

SOCKETS



Applications

Sockets are used as a connection to attach steel wire rope to a fixed point. This may be an anchoring system for tubes or pipes, anchor wires for dredging materials, anchor cables for oil platforms, fastening points for towing cables or for fastening cables in constructions such as bridges, roofs etc. Sockets are designed for in-line use only. Sockets are the strongest steel wire rope end fittings available. If they are assembled in the proper way they meet or exceed the breaking strength of the steel wire rope.

Range

Green Pin® offers a wide range of socket types in various sizes and shapes.

Design

Green Pin® open- and closed spelter sockets and Green Pin® open wedge sockets are made from cast high tensile steel.

These sockets are generally marked with:

- manufacturer's symbol - e.g. GP
- wire rope diameter in mm and inches - e.g. 20-22 and 7/8"
- traceability code - e.g. A01
- socket number - e.g. 104

Swage sockets are drop forged from special bar quality carbon steel C-1035 and spheroidized annealed to make them suitable for cold swaging.

Finish

Green Pin® open- and closed spelter sockets and open wedge sockets are galvanized. Swage sockets are self coloured.

Certification

Specific details of certificate availability can be found on each product page. Please verify your certification requirements at the time of order.

Instructions for use

1) Open spelter sockets – closed spelter sockets

In the past melted zinc was poured into the sockets to fix the steel wire rope; nowadays resins are used for this purpose.

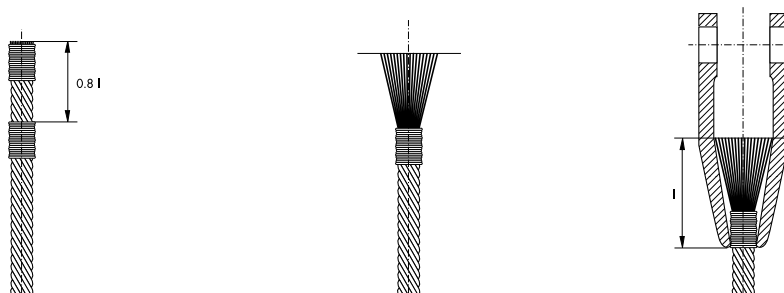

Figure 1

- brooming is done after the wire rope has been placed into the socket;
- when using resins always exactly follow the instructions given by the manufacturer carefully;
- socketing must be done by specialists in a certified sling shop.

2) Open wedge sockets

The wedge and body act as a vice which grips the wire rope and locks it in place. Green Pin® wedge sockets may be used within the range of wire rope diameters as shown in the table further on in the catalogue.

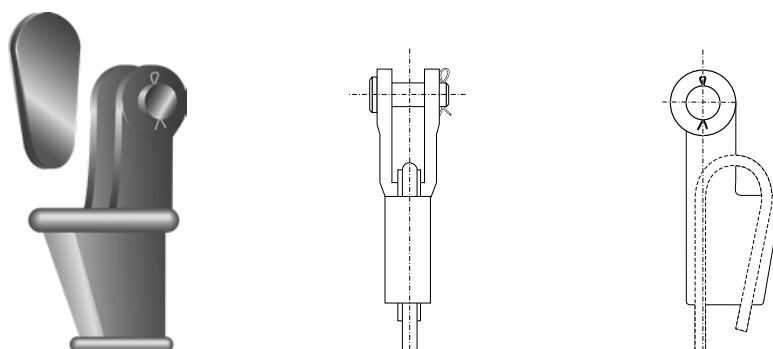

Figure 2

When using open wedge sockets the following precautions should be taken:

- before use always inspect the socket, the wedge and the pin;
- use only with standard 6-8 strand wire rope;
- always be sure that socket and wedge have the correct size for the wire rope diameter;
- the loaded part of the steel wire rope should be mounted in the centre line of the pin;
- when installing the wire rope, always pre-load the wedge with the wire rope in place;
- never weld the tail; the tail should have a length of at least 6 times the wire rope diameter with a minimum of 150 mm. Secure the dead end of the rope with a wire rope clip as shown in figure 3;
- before applying the first load always use a hammer to seat the wedge and rope into the socket as deep as possible;
- check the assembly regularly; re-tighten or re-position if necessary;
- never side load a wedge socket as it has not been designed for that purpose;
- load may slip if the connection is not properly installed;
- the efficiency of a wire rope - wedge socket connection is 80% of the minimum breaking load of the wire, but is limited to the minimum breaking load of the socket;
- only use the original wedge supplied by the manufacturer of the socket and be sure it is suitable for the diameter of the rope used;
- never use a wedge from any other supplier than the original socket supplier as the dimensions will not match.

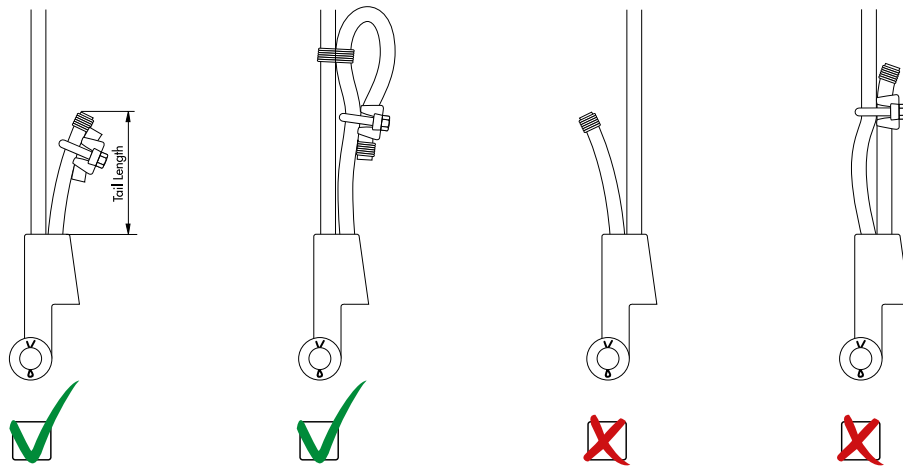

Figure 3

3) Swage sockets

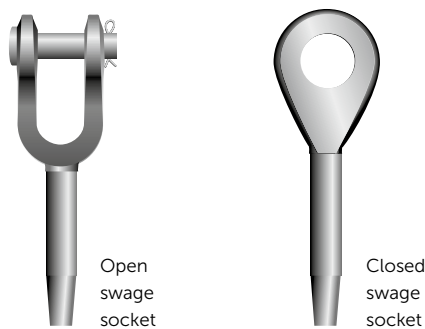

Figure 4

Swage Sockets are recommended for use on 6 x 19 or 6 x 37 IPS or XIP (EIP), XXIP (EEIP), RRL, FC, or IWRC wire ropes. They are also approved for use on galvanized bridge rope. Before using swage socket assemblies, it is recommended that the termination be proof loaded to prove the adequacy of the assembly. Always swage under supervision of a specialist from a certified sling shop.

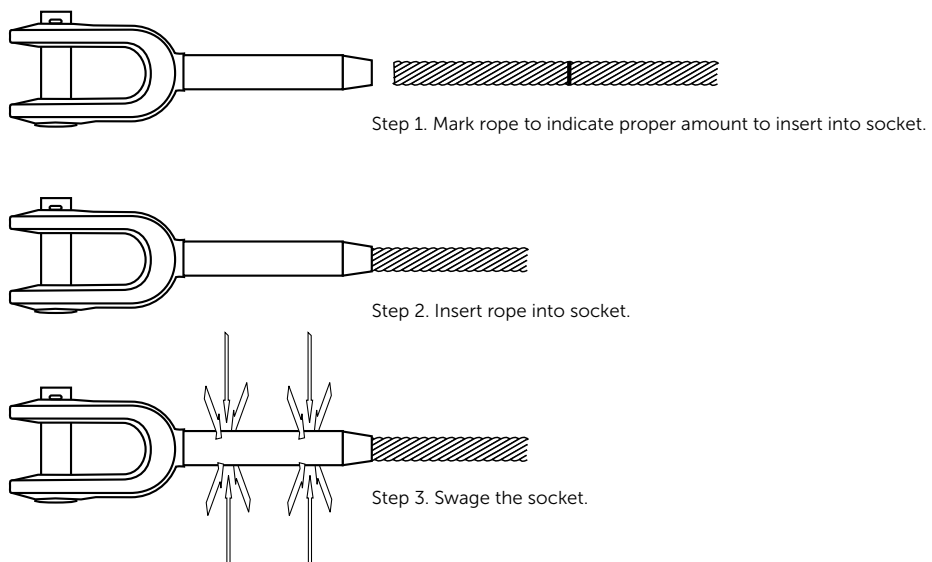

Figure 5

INFO

For more instructions on swaging we refer to the swaging instruction (PI-03-14 in the FAQ section) on our website.

Sockets must be regularly inspected in accordance with the safety standards given in the country of use. This is required because the products in use may be affected by wear, misuse, overloading etc. which may lead to deformation and alteration of the material structure. Inspection should take place at least every six months and more frequently when the sockets are used in severe operating conditions.



Green Pin® Closed Spelter Socket

- **Material:** high tensile steel
- **Finish:** hot dipped galvanized
- **Temperature Range:** -20°C up to +200°C
- **Certification:** 2.1 2.2 3.1 CE



G-6411

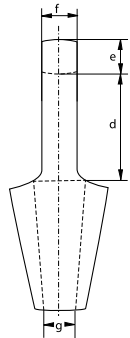
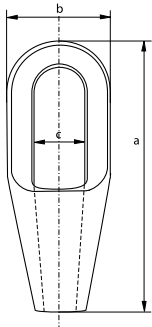

number	minimum breaking load	diameter wire rope	length	width	width inside bow	length inside bow	thickness bow	thickness bow	opening	weight each
	t	mm	a mm	b mm	c mm	d mm	e mm	f mm	g mm	kg
296	8	6 - 7	101	37	22	40	11	13	9	0.3
297	12	8 - 10	119	43	25	48	14	17.5	12	0.5
298	20	11 - 13	140	52	30	58	18	23.5	15	0.75
299	25	14 - 16	162	68	37	66	21	26	17.5	1.5
200	40	18 - 19	194	76	42	78	27	32	21.5	2.4
201	55	20 - 22	224	92	47	90	33	38	24	3.6
204	75	23 - 26	253	104	57	103	36	44	28	5.8
207	90	27 - 30	282	114	63	116	39	51	32	7
212	125	31 - 36	312	127	70	130	43	57	38	10.5
215	150	37 - 39	358	136	79	155	51	63	41	13
217	170	40 - 42	390	146	83	171	54	70	44	17
219	225	43 - 48	443	171	93	198	55	76	51	26
222	280	49 - 54	502	193	100	224	62	82	57	37.5
224	360	55 - 60	548	216	112	247	73	92	63	50
226	425	61 - 68	597	241	140	270	79	102	73	65
227	460	69 - 75	644	273	159	286	79	124	79	94
228	560	76 - 80	686	292	171	298	83	133	86	115
229	625	81 - 86	743	311	184	311	102	146	92	145
230	720	87 - 93	788	330	197	330	102	159	99	168
231	875	94 - 102	845	362	216	356	108	178	108	210
233	1200	108 - 115	1000	405	235	425	125	190	125	330
240	1300	120 - 130	1150	450	260	525	125	200	143	500

In inch

number	minimum breaking load	diameter wire rope	length	width	width inside bow	length inside bow	thickness bow	thickness bow	opening	weight each
	t	inch	a inch	b inch	c inch	d inch	e inch	f inch	g inch	lbs
296	8	1/4	3 31/32	1 1/2	7/8	1 19/32	7/16	1/2	11/32	0.66
297	12	3/8	4 11/16	1 23/32	1	1 29/32	9/16	11/16	15/32	1.10
298	20	7/16 - 1/2	5 17/32	2 1/32	1 3/16	2 9/32	23/32	15/16	19/32	1.54
299	25	9/16 - 5/8	6 11/32	2 11/16	1 1/2	2 19/32	13/16	1 1/32	11/16	3.31
200	40	3/4	7 5/8	3	1 11/16	3 3/32	1 3/32	1 9/32	27/32	5.29
201	55	7/8	8 13/16	3 5/8	1 7/8	3 9/16	1 5/16	1 17/32	15/16	7.94
204	75	1	9 31/32	4 3/32	2 1/4	4 1/32	1 7/16	1 3/4	1 1/8	12.79
207	90	1 1/8	11 1/8	4 1/2	2 1/2	4 9/16	1 9/16	2	1 9/32	15.43
212	125	1 1/4 - 1 3/8	12 9/32	5	2 3/4	5 1/8	1 23/32	2 1/4	1 17/32	23.1
215	150	1 1/2	14 3/32	5 11/32	3 1/8	6 3/32	2	2 1/2	1 5/8	28.7
217	170	1 5/8	15 11/32	5 3/4	3 9/32	6 23/32	2 1/8	2 3/4	1 3/4	37.5
219	225	1 3/4 - 1 7/8	17 1/2	6 23/32	3 11/16	7 25/32	2 5/32	3	2	57.3
222	280	2 - 2 1/8	19 25/32	7 19/32	3 15/16	8 13/16	2 7/16	3 1/4	2 1/4	82.7
224	360	2 1/4 - 2 3/8	21 19/32	8 17/32	4 3/8	9 3/4	2 7/8	3 5/8	2 1/2	110.2
226	425	2 1/2 - 2 5/8	23 17/32	9 17/32	5 17/32	10 5/8	3 1/8	4	2 7/8	143.3
227	460	2 3/4 - 2 7/8	25 11/32	10 3/4	6 1/4	11 9/32	3 1/8	4 7/8	3 1/8	207.2
228	560	3 - 3 1/8	27	11 17/32	6 23/32	11 3/4	3 9/32	5 1/4	3 3/8	254
229	625	3 1/4 - 3 3/8	29 1/4	12 1/4	7 1/4	12 1/4	4	5 3/4	3 5/8	320
230	720	3 1/2 - 3 5/8	31	13	7 3/4	13	4	6 1/4	3 29/32	370
231	875	3 3/4 - 4	33 9/32	14 1/4	8 17/32	14	4 1/4	7	4 1/4	463
233	1200	4 1/4 - 4 1/2	39 3/8	15 15/16	9 9/32	16 3/4	4 29/32	7 1/2	4 29/32	728
240	1300	4 3/4 - 5	45 9/32	17 3/4	10 1/4	20 11/16	4 29/32	7 7/8	5 5/8	1102





Green Pin® Open Spelter Socket CP

Open spelter socket with cotter pin

- **Material:** high tensile steel
- **Finish:** hot dipped galvanized
- **Temperature Range:** -20°C up to +200°C
- **Certification:** 2.1 2.2 3.1 CE

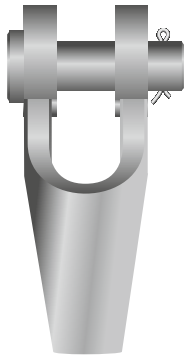

G-6412

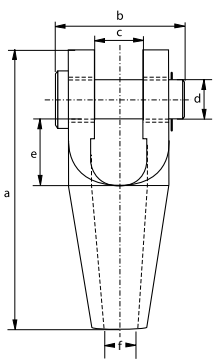

number	minimum breaking load	diameter wire rope	length	width	width inside	diameter pin	length inside	opening	weight each
	t	mm	a mm	b mm	c mm	d mm	e mm	f mm	kg
196	8	6 - 7	109	51	19	16	33	9	0.4
197	12	8 - 10	124	62	21	21	34	12	0.7
198	20	11 - 13	143	66	26	25	37	15	1
199	25	14 - 16	172	82	33	30	49	18	1.8
100	40	18 - 19	205	95	38	35	58	21	3
104	55	20 - 22	235	110	44	41	68	24	4.6
108	75	23 - 26	275	130	51	51	75	28	8
111	90	27 - 30	306	144	57	57	85	32	11
115	125	31 - 36	338	155	63	64	95	38	16
118	150	37 - 39	394	178	76	70	127	41	22
120	170	40 - 42	418	187	76	76	127	44	27
125	225	43 - 48	468	213	89	89	134	51	41
128	280	49 - 54	552	240	101	95	181	57	64
130	360	55 - 60	598	270	113	108	196	63	88
132	425	61 - 68	654	303	127	121	213	73	125
135	460	69 - 75	696	349	133	127	216	79	155
138	560	76 - 80	737	371	146	133	220	86	187
140	625	81 - 86	788	391	159	140	228	92	230
142	720	87 - 93	852	411	171	152	242	99	265
144	875	94 - 102	914	447	191	178	254	108	400
146	1200	108 - 115	1160	489	206	193	369	125	660

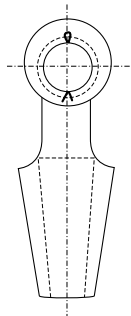

In inch

number	minimum breaking load	diameter wire rope	length	width	width inside	diameter pin	length inside	opening	weight each
	t	inch	a inch	b inch	c inch	d inch	e inch	f inch	lbs
196	8	1/4	4 9/32	2	3/4	5/8	1 5/16	11/32	0.88
197	12	3/8	4 7/8	2 7/16	13/16	13/16	1 11/32	15/32	1.54
198	20	7/16 - 1/2	5 5/8	2 19/32	1 1/32	1	1 1/2	19/32	2.20
199	25	9/16 - 5/8	6 3/4	3 1/4	1 5/16	1 3/16	1 15/16	23/32	3.97
100	40	3/4	8 3/32	3 3/4	1 17/32	1 3/8	2 9/32	13/16	6.61
104	55	7/8	9 9/32	4 5/16	1 3/4	1 5/8	2 11/16	15/16	10.14
108	75	1	10 13/16	5 1/8	2	2	2 15/16	1 1/8	17.64
111	90	1 1/8	12 1/32	5 11/16	2 1/4	2 1/4	3 11/32	1 9/32	24.3
115	125	1 1/4 - 1 3/8	13 5/16	6 3/32	2 1/2	2 17/32	3 3/4	1 17/32	35.3
118	150	1 1/2	15 17/32	7	3	2 3/4	5	1 5/8	48.5
120	170	1 5/8	16 1/2	7 11/32	3	3	5	1 3/4	59.5
125	225	1 3/4 - 1 7/8	18 7/16	8 3/8	3 17/32	3 17/32	5 9/32	2	90.4
128	280	2 - 2 1/8	21 3/4	9 1/2	3 31/32	3 3/4	7 1/8	2 1/4	141.1
130	360	2 1/4 - 2 3/8	23 9/16	10 5/8	4 7/16	4 1/4	7 23/32	2 1/2	194
132	425	2 1/2 - 2 5/8	25 3/4	11 15/16	5	4 3/4	8 3/8	2 7/8	276
135	460	2 3/4 - 2 7/8	27 3/8	13 3/4	5 1/4	5	8 17/32	3 1/8	342
138	560	3 - 3 1/8	29	14 19/32	5 3/4	5 1/4	8 11/16	3 3/8	412
140	625	3 1/4 - 3 3/8	31	15 3/8	6 1/4	5 17/32	9	3 5/8	507
142	720	3 1/2 - 3 5/8	33 9/16	16 3/16	6 23/32	5 31/32	9 9/16	3 29/32	584
144	875	3 3/4 - 4	35 31/32	17 5/8	7 17/32	7	10	4 1/4	882
146	1200	4 1/4 - 4 1/2	45 11/16	19 9/32	8 1/8	7 19/32	14 17/32	4 29/32	1455

CAD



Green Pin® Open Spelter Socket BN

Open spelter socket with safety bolt

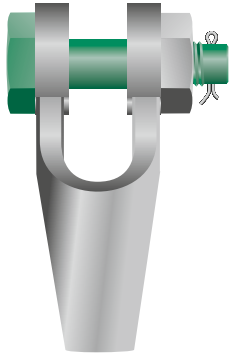

G-6422

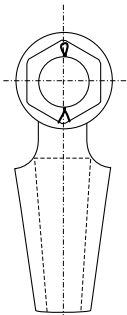
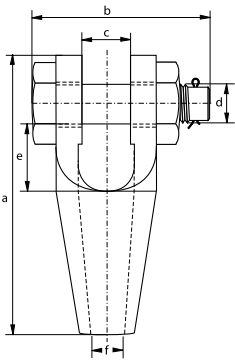

- **Material:** high tensile steel
- **Finish:** hot dipped galvanized
- **Temperature Range:** -20°C up to +200°C
- **Certification:** 2.1 2.2 3.1 CE

number	minimum breaking load	diameter wire rope	length	width	width inside	diameter pin	length inside	opening	weight each
	t	mm	a mm	b mm	c mm	d mm	e mm	f mm	kg
196	8	6 - 7	109	69	19	16	33	9	0.4
197	12	8 - 10	124	83	21	20	35	12	0.8
198	20	11 - 13	143	101	26	25	37	15	1.3
199	25	14 - 16	172	124	33	30	49	18	2.3
100	40	18 - 19	205	138	38	35	58	21	3.7
104	55	20 - 22	235	148	44	41	68	24	4.6
108	75	23 - 26	275	176	51	50	76	28	9.7
111	90	27 - 30	306	193	57	57	85	32	13.6
115	125	31 - 36	338	210	63	63	96	38	16
118	150	37 - 39	394	230	76	70	127	41	26.9
120	170	40 - 42	418	244	76	77	126	44	32

In inch

number	minimum breaking load	diameter wire rope	length	width	width inside	diameter pin	length inside	opening	weight each
	t	inch	a inch	b inch	c inch	d inch	e inch	f inch	lbs
196	8	1/4	4 9/32	2 23/32	3/4	5/8	1 5/16	11/32	0.88
197	12	3/8	4 7/8	3 9/32	13/16	25/32	1 3/8	15/32	1.76
198	20	7/16 - 1/2	5 5/8	3 31/32	1 1/32	1	1 1/2	19/32	2.87
199	25	9/16 - 5/8	6 3/4	4 7/8	1 5/16	1 3/16	1 15/16	23/32	5.07
100	40	3/4	8 3/32	5 7/16	1 17/32	1 3/8	2 9/32	13/16	8.16
104	55	7/8	9 9/32	5 13/16	1 3/4	1 5/8	2 11/16	15/16	10.14
108	75	1	10 13/16	6 29/32	2	1 31/32	3	1 1/8	21.38
111	90	1 1/8	12 1/32	7 19/32	2 1/4	2 1/4	3 11/32	1 9/32	30.0
115	125	1 1/4 - 1 3/8	13 5/16	8 9/32	2 1/2	2 1/2	3 25/32	1 17/32	35.3
118	150	1 1/2	15 17/32	9 3/32	3	2 3/4	5	1 5/8	59.3
120	170	1 5/8	16 1/2	9 5/8	3	3 1/32	4 15/16	1 3/4	70.5

CAD



Green Pin® Open Wedge Socket CP

Open wedge socket with cotter pin



G-6413

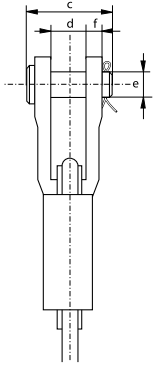
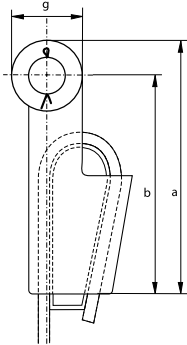

- **Material:** high tensile steel
- **Standard:** generally to EN 13411-6
- **Finish:** hot dipped galvanized
- **Temperature Range:** -20°C up to +200°C
- **Certification:** 2.1 2.2 3.1 CE

number	minimum breaking load	diameter wire rope	length	length to center pin	width	width inside	diameter pin	thickness side plates	diameter eye	weight each
	t	mm	a mm	b mm	c mm	d mm	e mm	f mm	g mm	kg
0.25	8	7 - 8	128	110	51	18	16	9	36	0.8
0.5	12	9 - 10	165	142	62	20.5	21	11	46	1.5
1	20	11 - 13	175	146	66	25	25	12	57	2.4
2	25	14 - 16	211	176	82	31	30	15	70	4
3	40	18 - 19	252	212	95	38	35	16	80	7.4
4	55	20 - 22	288	240	110	44	41	19	95	11
5	75	24 - 26	329	274	130	51	51	22	110	16
6	90	27 - 29	375	310	144	57	57	25	130	22
7	110	30 - 32	423	350	155	63	64	28	146	31
8	125	34 - 36	474	400	163	69	64	28	148	39
9	150	37 - 39	527	450	178	76	70	30	153	48
10	170	40 - 42	580	500	187	76	76	33	160	64
11	225	43 - 48	650	550	226	89	89	39	186	96
12	280	49 - 52	745	640	240	101	95	46	194	130
13	360	54 - 58	785	660	275	114	108	54	230	180
14	425	60 - 66	970	835	300	127	121	60	250	275
15	460	72 - 78	1150	1000	355	146	133	76	270	440
16	625	81 - 86	1252	1100	375	159	140	79	300	510

In inch

number	minimum breaking load	diameter wire rope	length	length to center pin	width	width inside	diameter pin	thickness side plates	diameter eye	weight each
	t	inch	a inch	b inch	c inch	d inch	e inch	f inch	g inch	lbs
0.25	8	5/16	5 1/32	4 5/16	2	23/32	5/8	11/32	1 7/16	1.76
0.5	12	3/8	6 1/2	5 19/32	2 7/16	13/16	13/16	7/16	1 13/16	3.31
1	20	1/2	6 7/8	5 3/4	2 19/32	1	1	15/32	2 1/4	5.29
2	25	5/8	8 5/16	6 29/32	3 1/4	1 1/4	1 3/16	19/32	2 3/4	8.82
3	40	3/4	9 15/16	8 11/32	3 3/4	1 17/32	1 3/8	5/8	3 5/32	16.31
4	55	7/8	11 11/32	9 1/2	4 5/16	1 3/4	1 5/8	3/4	3 3/4	24.3
5	75	1	12 15/16	10 25/32	5 1/8	2	2	7/8	4 5/16	35.3
6	90	1 1/8	14 3/4	12 3/16	5 11/16	2 1/4	2 1/4	1	5 1/8	48.5
7	110	1 1/4	16 11/16	13 25/32	6 3/32	2 1/2	2 17/32	1 1/8	5 3/4	68.3
8	125	1 3/8	18 11/16	15 3/4	6 3/8	2 23/32	2 17/32	1 1/8	5 13/16	86.0
9	150	1 1/2	20 3/4	17 3/4	7	3	2 3/4	1 3/16	6	105.8
10	170	1 5/8	22 13/16	19 23/32	7 11/32	3	3	1 5/16	6 9/32	141.1
11	225	1 3/4 - 1 7/8	25 19/32	21 11/16	8 29/32	3 17/32	3 17/32	1 9/16	7 5/16	212
12	280	2	29 5/16	25 3/16	9 1/2	3 31/32	3 3/4	1 13/16	7 5/8	287
13	360	2 1/4	30 7/8	25 31/32	10 13/16	4 1/2	4 1/4	2 1/8	9 3/32	397
14	425	2 1/2	38 5/32	32 7/8	11 13/16	5	4 3/4	2 11/32	9 7/8	606
15	460	3	45 9/32	39 3/8	13 31/32	5 3/4	5 1/4	3	10 5/8	970
16	625	3 1/4 - 3 3/8	49 5/16	43 5/16	14 3/4	6 1/4	5 17/32	3 1/8	11 13/16	1124

CAD



Green Pin® Open Wedge Socket BN

Open wedge socket with safety bolt



G-6423

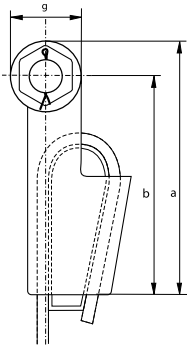

- **Material:** high tensile steel
- **Standard:** generally to EN 13411-6
- **Finish:** hot dipped galvanized
- **Temperature Range:** -20°C up to +200°C
- **Certification:** 2.1 2.2 3.1 CE

number	minimum breaking load	diameter wire rope	length	length to center pin	width	width inside	diameter pin	thickness side plates	diameter eye	weight each
	t	mm	a mm	b mm	c mm	d mm	e mm	f mm	g mm	kg
0.25	8	7 - 8	128	110	69	18	16	9	36	0.8
0.5	12	9 - 10	165	142	83	20.5	20	11	46	1.5
1	20	11 - 13	175	146	101	25	25	12	57	2.4
2	25	14 - 16	211	176	124	31	30	15	70	4.8
3	40	18 - 19	252	212	138	38	35	16	80	8.3
4	55	20 - 22	288	240	148	44	41	19	95	11
5	75	24 - 26	329	274	176	51	50	22	110	17.9
6	90	27 - 29	375	310	193	57	57	25	130	21
7	110	30 - 32	423	350	210	63	63	28	146	33
8	125	34 - 36	474	400	216	69	65	28	148	42
9	150	37 - 39	527	450	230	76	70	30	153	52
10	170	40 - 42	580	500	244	76	77	33	160	73

In inch

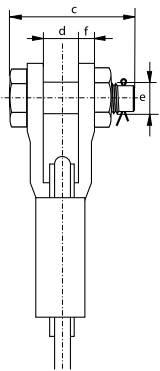

number	minimum breaking load	diameter wire rope	length	length to center pin	width	width inside	diameter pin	thickness side plates	diameter eye	weight each
	t	inch	a inch	b inch	c inch	d inch	e inch	f inch	g inch	lbs
0.25	8	$\frac{5}{16}$	$5 \frac{1}{32}$	$4 \frac{5}{16}$	$2 \frac{23}{32}$	$\frac{23}{32}$	$\frac{5}{8}$	$\frac{11}{32}$	$1 \frac{7}{16}$	1.76
0.5	12	$\frac{3}{8}$	$6 \frac{1}{2}$	$5 \frac{19}{32}$	$3 \frac{9}{32}$	$\frac{13}{16}$	$\frac{25}{32}$	$\frac{7}{16}$	$1 \frac{13}{16}$	3.31
1	20	$\frac{1}{2}$	$6 \frac{7}{8}$	$5 \frac{3}{4}$	$3 \frac{31}{32}$	1	1	$\frac{15}{32}$	$2 \frac{1}{4}$	5.29
2	25	$\frac{5}{8}$	$8 \frac{5}{16}$	$6 \frac{29}{32}$	$4 \frac{7}{8}$	$1 \frac{1}{4}$	$1 \frac{3}{16}$	$\frac{19}{32}$	$2 \frac{3}{4}$	10.58
3	40	$\frac{3}{4}$	$9 \frac{15}{16}$	$8 \frac{11}{32}$	$5 \frac{7}{16}$	$1 \frac{17}{32}$	$1 \frac{3}{8}$	$\frac{5}{8}$	$3 \frac{5}{32}$	18.3
4	55	$\frac{7}{8}$	$11 \frac{11}{32}$	$9 \frac{1}{2}$	$5 \frac{13}{16}$	$1 \frac{3}{4}$	$1 \frac{5}{8}$	$\frac{3}{4}$	$3 \frac{3}{4}$	24.3
5	75	1	$12 \frac{15}{16}$	$10 \frac{25}{32}$	$6 \frac{29}{32}$	2	$1 \frac{31}{32}$	$\frac{7}{8}$	$4 \frac{5}{16}$	39.5
6	90	$1 \frac{1}{8}$	$14 \frac{3}{4}$	$12 \frac{3}{16}$	$7 \frac{19}{32}$	$2 \frac{1}{4}$	$2 \frac{1}{4}$	1	$5 \frac{1}{8}$	46.3
7	110	$1 \frac{1}{4}$	$16 \frac{11}{16}$	$13 \frac{25}{32}$	$8 \frac{9}{32}$	$2 \frac{1}{2}$	$2 \frac{1}{2}$	$1 \frac{1}{8}$	$5 \frac{3}{4}$	72.8
8	125	$1 \frac{3}{8}$	$18 \frac{11}{16}$	$15 \frac{3}{4}$	$8 \frac{17}{32}$	$2 \frac{23}{32}$	$2 \frac{9}{16}$	$1 \frac{1}{8}$	$5 \frac{13}{16}$	92.6
9	150	$1 \frac{1}{2}$	$20 \frac{3}{4}$	$17 \frac{3}{4}$	$9 \frac{3}{32}$	3	$2 \frac{3}{4}$	$1 \frac{3}{16}$	6	114.6
10	170	$1 \frac{5}{8}$	$22 \frac{13}{16}$	$19 \frac{23}{32}$	$9 \frac{5}{8}$	3	$3 \frac{1}{32}$	$1 \frac{5}{16}$	$6 \frac{9}{32}$	160.9

CAD



Green Pin® Short Bow Socket

Closed spelter socket

- **Material:** cast alloy steel
- **Finish:** hot dipped galvanized
- **Certification:** 2.1 2.2 3.1 CE



G-6416

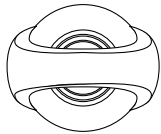
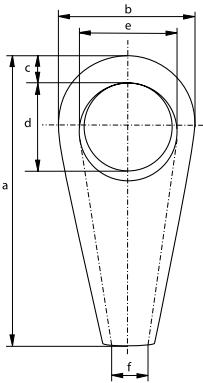

minimum breaking load	rope size	length	width	thicknes bow	length eye	width eye	opening	weight each
t	mm	a mm	b mm	c mm	d mm	e mm	f mm	kg
140	31-36	262	132	38	83	75	39	7
160	37-42	305	152	40	103	92	44	10
200	43-48	356	178	48	120	112	51	16
250	49-54	390	200	54	132	120	59	21
320	55-60	440	220	62	148	135	64	28
400	61-68	498	250	68	165	150	73	44
500	69-75	540	274	75	178	164	79	53
600	76-80	585	295	76	195	175	89	70
700	81-86	625	320	82	216	194	92	81
800	87-93	670	350	92	220	202	99	112
900	94-102	700	375	100	235	215	108	130
1000	108-115	800	410	110	270	240	120	182

In inch

minimum breaking load	rope size	length	width	thicknes bow	length eye	width eye	opening	weight each
t	inch	a inch	b inch	c inch	d inch	e inch	f inch	lbs
140	1 1/4 - 1 3/8	10 5/16	5 3/16	1 1/2	3 9/32	2 15/16	1 17/32	15.4
160	1 1/2 - 1 5/8	12	5 31/32	1 9/16	4 1/16	3 5/8	1 23/32	22.1
200	1 3/4 - 1 7/8	14 1/32	7	1 7/8	4 23/32	4 13/32	2	35.3
250	2 - 2 1/8	15 11/32	7 7/8	2 1/8	5 3/16	4 23/32	2 5/16	46.3
320	2 1/4 - 2 3/8	17 5/16	8 21/32	2 7/16	5 13/16	5 5/16	2 17/32	61.7
400	2 1/2 - 2 5/8	19 19/32	9 27/32	2 11/16	6 1/2	5 29/32	2 7/8	97
500	2 3/4 - 2 7/8	21 1/4	10 25/32	2 15/16	7	6 15/32	3 1/8	116.9
600	3 - 3 1/8	23 1/32	11 5/8	3	7 11/16	6 7/8	3 1/2	154.3
700	3 1/4 - 3 3/8	24 19/32	12 19/32	3 7/32	8 1/2	7 5/8	3 5/8	178.6
800	3 1/2 - 3 5/8	26 3/8	13 25/32	3 5/8	8 21/32	7 15/16	3 29/32	246.9
900	3 3/4 - 4	27 9/16	14 3/4	3 15/16	9 1/4	8 15/32	4 1/4	286.6
1000	4 1/4 - 4 1/2	31 1/2	16 5/32	4 11/32	10 5/8	9 7/16	4 23/32	401.3

Green Pin® Open Swage Socket CP

Open type swage socket with cotter pin

- **Material:** drop forged steel C-1035
- **Finish:** self coloured
- **Certification:** 2.1



S-6414

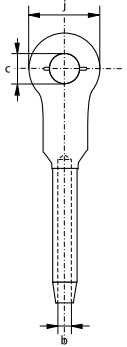
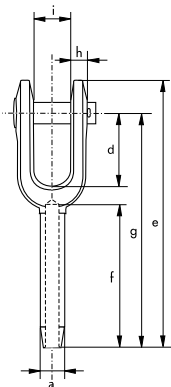

diameter rope	diameter before swage	diameter after swage		diameter inside	diameter pin	length	length	length	length	thickness	width inside	width eye	weight each
		min	max										
mm	a	a	a	b	c	d	e	f	g	h	i	j	kg
6	13	10.9	11.7	7	17	38	121	54	102	8	17	35	0.25
8	20	17.2	18.0	9	21	44	159	81	135	10	21	41	0.57
10	20	17.2	18.0	10	21	44	159	81	135	10	21	41	0.56
11	25	22.0	23.1	12	25	51	198	108	169	13	25	51	1.11
13	25	22.0	23.1	14	25	51	198	108	169	13	25	51	1.08
14	32	28.3	29.5	15	30	57	243	135	206	16	32	63	2.11
16	32	28.3	29.5	17	30	57	243	135	206	16	32	63	2.06
19	39	34.7	36.1	20	35	70	297	162	254	19	38	76	3.68
22	43	37.8	39.4	24	41	83	346	189	295	23	44	86	5.38
25	50	44.2	45.7	27	51	95	397	216	340	26	51	102	5.45
28	57	50.5	52.1	30	57	108	444	243	381	30	57	114	12
32	64	56.9	58.4	34	64	121	494	270	419	30	63	127	16.2
35	71	63.2	65.0	37	64	133	540	297	460	33	63	133	20.5
38	78	69.6	71.4	40	70	146	591	324	502	37	76	146	29.5
44	86	75.9	77.7	47	89	171	689	378	584	43	89	178	42.2
51	100	88.6	90.4	54	95	203	798	432	679	46	102	203	65.8
57	113	100.3	102.1	60	108	171	835	486	705	65	114	222	93.4
63	125	110.5	112.3	67	108	171	879	498	749	65	114	222	103
76	151	133.1	134.9	80	133	219	1045	603	905	76	146	241	181

In inch

diameter rope	diameter before swage	diameter after swage		diameter inside	diameter pin	length	length	length	length	thickness	width inside	width eye	weight each
		min	max										
inch	a	a	a	b	c	d	e	f	g	h	i	j	lbs
1/4	0.495	0.428	0.460	0.272	11/16	1 1/2	4 3/4	2 1/8	4	5/16	11/16	1 3/8	0.57
5/16	0.770	0.678	0.710	0.339	13/16	1 3/4	6 1/4	3 3/16	5 5/16	13/32	13/16	1 5/8	1.25
3/8	0.770	0.678	0.710	0.406	13/16	1 3/4	6 1/4	3 3/16	5 5/16	13/32	13/16	1 5/8	1.20
7/16	0.982	0.865	0.910	0.484	1	2	7 13/16	4 1/4	6 11/16	1/2	1	2	2.45
1/2	0.982	0.865	0.910	0.547	1	2	7 13/16	4 1/4	6 11/16	1/2	1	2	2.40
9/16	1.257	1.115	1.160	0.609	1 3/16	2 1/4	9 9/16	5 5/16	8 1/8	5/8	1 1/4	2 1/2	4.80
5/8	1.257	1.115	1.160	0.672	1 3/16	2 1/4	9 9/16	5 5/16	8 1/8	5/8	1 1/4	2 1/2	4.50
3/4	1.545	1.365	1.420	0.796	1 3/8	2 3/4	11 11/16	6 3/8	10	3/4	1 1/2	3	7.80
7/8	1.700	1.490	1.550	0.938	1 5/8	3 1/4	13 5/8	7 7/16	11 5/8	15/16	1 3/4	3 3/8	11.8
1	1.975	1.740	1.800	1.062	2	3 3/4	15 5/8	8 1/2	13 3/8	1 1/32	2	4	17.8
1 1/8	2.245	1.990	2.050	1.188	2 1/4	4 1/4	17 1/2	9 9/16	15	1 3/16	2 1/4	4 1/2	28.9
1 1/4	2.525	2.240	2.300	1.328	2 1/2	4 3/4	19 7/16	10 5/8	16 1/2	1 3/16	2 1/2	5	36.2
1 3/8	2.800	2.490	2.560	1.453	2 1/2	5 1/4	21 1/4	11 11/16	18 1/8	1 5/16	2 1/2	5 1/4	47.7
1 1/2	3.075	2.740	2.810	1.578	2 3/4	5 3/4	23 1/4	12 3/4	19 3/4	1 7/16	3	5 3/4	64.4
1 3/4	3.385	2.990	3.060	1.859	3 1/2	6 3/4	27 1/8	14 7/8	23	1 11/16	3 1/2	7	93.4
2	3.935	3.490	3.560	2.109	3 3/4	8	31 7/16	17	26 3/4	1 13/16	4	8	148
2 1/4	4.450	3.950	4.020	2.360	4 1/4	6 3/4	32 7/8	19 1/8	27 3/4	2 9/16	4 1/2	8 3/4	173
2 1/2	4.930	4.350	4.420	2.657	4 1/4	6 3/4	34 5/8	19 5/8	29 1/2	2 9/16	4 1/2	8 3/4	233
3	5.960	5.240	5.310	3.166	5 1/4	8 5/8	41 1/8	23 3/4	35 5/8	3	5 3/4	9 1/2	382

CAD



Green Pin® Closed Swage Socket

Closed type

- **Material:** drop forged steel C-1035
- **Finish:** self coloured
- **Certification:** 2.1



S-6415

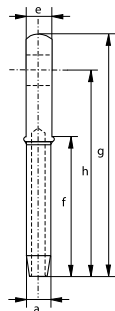
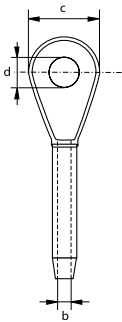

diameter rope	diameter before swage	diameter after swage		diameter inside	diameter	diameter eye	thickness	length	length	length	weight each
		min	max								
mm	a	a	a	b	c	d	e	f	g	h	kg
6	13	10.9	11.7	7	37	19	13	54	111	89	0.15
8	20	17.2	18.0	9	43	22	17	81	140	114	0.35
10	20	17.2	18.0	10	43	22	17	81	140	114	0.33
11	25	22.0	23.1	12	51	27	22	108	176	146	0.66
13	25	22.0	23.1	14	51	27	22	108	176	146	0.62
14	32	28.3	29.5	15	63	32	29	135	222	184	1.35
16	32	28.3	29.5	17	63	32	29	135	222	184	1.31
19	39	34.7	36.1	20	76	37	33	162	264	219	2.3
22	43	37.8	39.4	24	89	43	38	189	308	257	3.40
25	50	44.2	45.7	27	102	52	44	216	349	292	4.97
28	57	50.5	52.1	30	114	59	51	243	387	324	7.17
32	64	56.9	58.4	34	127	65	57	270	438	365	10.4
35	71	63.2	65.0	37	133	65	57	297	479	400	13.3
38	78	69.6	71.4	40	140	71	63	324	518	432	17.7
44	86	75.9	77.7	47	171	91	76	378	610	508	23.6
51	100	88.6	90.4	54	197	97	83	432	698	584	40.8
57	113	100.3	102.1	60	219	110	102	486	756	632	55.3
63	125	110.5	112.3	67	219	110	102	498	791	667	64.4
76	151	133.1	134.9	80	235	135	137	603	959	816	114

In inch

diameter rope	diameter before swage	diameter after swage		diameter inside	diameter	diameter eye	thickness	length	length	length	weight each
		min	max								
inch	a	a	a	b	c	d	e	f	g	h	lbs
1/4	0.495	0.428	0.460	0.272	1 7/16	3/4	1/2	2 1/8	4 3/8	3 1/2	0.35
5/16	0.770	0.678	0.710	0.339	1 11/16	7/8	11/16	3 3/16	5 1/2	4 1/2	0.77
3/8	0.770	0.678	0.710	0.406	1 11/16	7/8	11/16	3 3/16	5 1/2	4 1/2	0.73
7/16	0.982	0.865	0.910	0.484	2	1 1/16	7/8	4 1/4	6 15/16	5 3/4	1.47
1/2	0.982	0.865	0.910	0.547	2	1 1/16	7/8	4 1/4	6 15/16	5 3/4	1.38
9/16	1.257	1.115	1.160	0.609	2 1/2	1 1/4	1 1/8	5 5/16	8 3/4	7 1/4	2.90
5/8	1.257	1.115	1.160	0.672	2 1/2	1 1/4	1 1/8	5 5/16	8 3/4	7 1/4	2.80
3/4	1.545	1.365	1.420	0.796	3	1 7/16	1 5/16	6 3/8	10 3/8	8 5/8	5.16
7/8	1.700	1.490	1.550	0.938	3 1/2	1 11/16	1 1/2	7 7/16	12 1/8	10 1/8	7.40
1	1.975	1.740	1.800	1.062	4	2 1/16	1 3/4	8 1/2	13 3/4	11 1/2	11.2
1 1/8	2.245	1.990	2.050	1.188	4 1/2	2 5/16	2	9 9/16	15 1/4	12 3/4	16
1 1/4	2.525	2.240	2.300	1.328	5	2 9/16	2 1/4	10 5/8	17 1/4	14 3/8	22.7
1 3/8	2.800	2.490	2.560	1.453	5 1/4	2 9/16	2 1/4	11 11/16	18 7/8	15 3/4	29
1 1/2	3.075	2.740	2.810	1.578	5 1/2	2 13/16	2 1/2	12 3/4	20 3/8	17	37.5
1 3/4	3.385	2.990	3.060	1.859	6 3/4	3 9/16	3	14 7/8	24	20	55.7
2	3.935	3.490	3.560	2.109	7 3/4	3 13/16	3 1/4	17	27 1/2	23	90
2 1/4	4.450	3.950	4.020	2.360	8 5/8	4 5/16	4	19 1/8	29 3/4	24 7/8	125
2 1/2	4.930	4.350	4.420	2.657	8 5/8	4 5/16	4	19 5/8	31 1/8	26 1/4	142
3	5.960	5.240	5.310	3.166	9 1/4	5 5/16	5 5/8	23 3/4	37 3/4	32 1/8	252

CAD

